

**Anschlußschema**

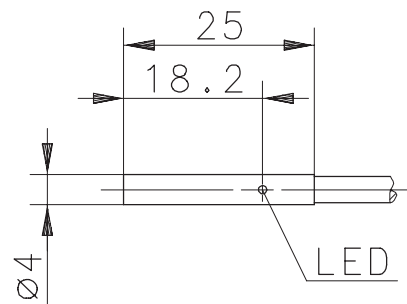
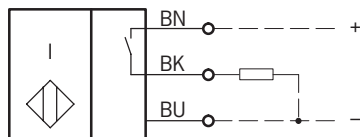

**Kenndaten nach EN 60947-5-2**

**Elektrische Daten**

Bemessungsbetriebsspannungsbereich	$U_B$	10 - 30V DC
Bemessungsisolationsspannung	$U_i$	75V DC
Bemessungsstoßspannungsfestigkeit	$U_{imp}$	500V
Spannungsfall	$U_d$	< 0,6V bei 100mA (zuzüglich 0,06V pro m Anschlußleitung und 200mA Last bei 20°C)
Gebrauchskategorie		DC-13
Bemessungsbetriebsstrom	$I_e$	≤ 200mA
Leerlaufstrom	$I_0$	< 13mA
Schutzart		IP 67
Art des Kurzschlußschutzes		taktend
Bemessungsschaltabstand	$s_n$	0,8mm
gesicherter Schaltabstand	$s_a$	0 ... 0,6mm
Wiederholgenauigkeit	R	< 5%
Hysterese	H	≈ 5%
Schaltfrequenz	f	3000Hz
Schaltelementfunktion		DC, Schließer
Einbauart		bündig
Verpolschutz		ja
Ausgang		dauerkurzschluß- und überlastfest

**Elektromagnetische Verträglichkeit (EMV)**

Hochfrequenzbeeinflussungsfestigkeit	IEC 61000-4-3
Elektrostatische Entladungsfestigkeit	IEC 61000-4-2
Transientenfestigkeit	IEC 61000-4-4
Störaussendung	EN55011
Stoßspannungsfestigkeit	IEC 255-5

**Mechanische Daten**

Umgebungstemperatur	-25°C bis +70°C
Frontkappe	LCP, schwarz
Gehäuse	Niro 1.4401 (V4A)
Funktionsanzeige	LED, gelb
Anschlußart	Kabel 3 x 0,14mm <sup>2</sup> x 2m, PUR-Mantel, schwarz

# Technical Data

## Inductive Proximity Switch

Type: **KIB-D04PS/0,8-KL2PU**

Part.-No.: **650.2999.004**

### Wiring Diagram

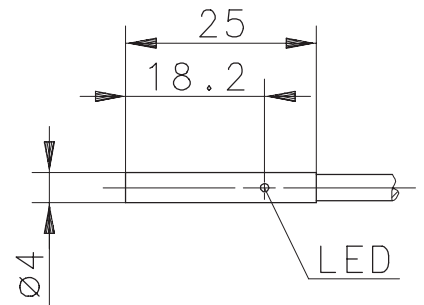
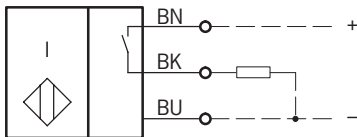

### Technical Data according to EN 60947-5-2

#### Electrical Data

Operational voltage range	$U_B$	10 - 30V DC
Rated insulation voltage	$U_i$	75V DC
Rated impulse withstand voltage	$U_{imp}$	500V
Voltage drop	$U_d$	< 0,6V @ 100mA (add. 0,06V per m cable and 200mA Load at 20 °C)
Utilization category		DC-13
Rated operational current	$I_e$	≤ 200mA
No-load supply current	$I_0$	< 13mA
Type of protection		IP 67
Short-circuit protection		pulsed
Rated operating distance	$S_n$	0,8mm
Assured operating distance	$S_a$	0 ... 0,6mm
Repeat accuracy	R	< 5%
Differential travel (hysteresis)	H	≈ 5%
Frequency of operating cycles	f	3000Hz
Switching function		DC, N.O.
Mounting		flush
False polarity protection		yes
Output		permanent overload and s.c.p.

#### Elektromagnetic compatibility (EMC)

Electromagnetic field test	IEC 61000-4-3
Electrostatic discharge test	IEC 61000-4-2
Electrical fast transient immunity test	IEC 61000-4-4
Radiated disturbance field strength	EN55011
Impulse voltage withstandability	IEC 255-5

#### Mechanical Data

Operating temperature	-25°C bis +70°C
Front cap	LCP, black
Housing	stainless steel (Niro 1.4401)
Indication	LED, yellow
Termination type	Cable 3 x 0,14mm <sup>2</sup> x 2m; PUR - Outer jacket, black